

지 지 대

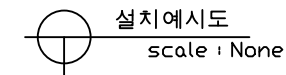

PROJECT TITLE	AL 안전그레이팅	SUBJECT TITLE		DATE	
MATERIAL		WEIGHT		SIZE	95*25*1000

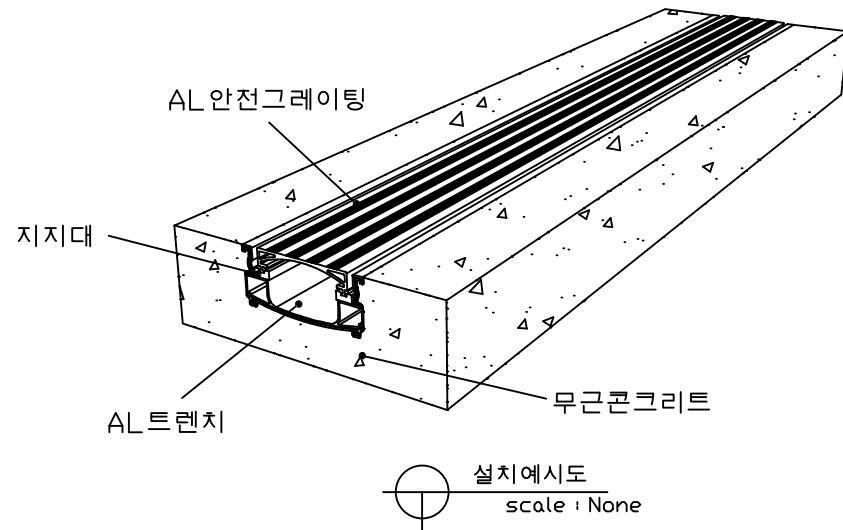
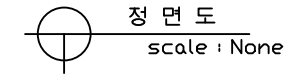
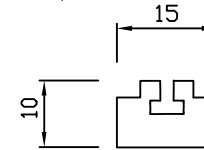
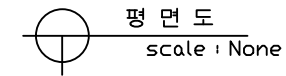
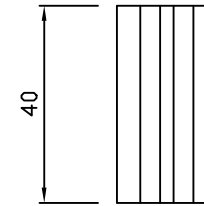
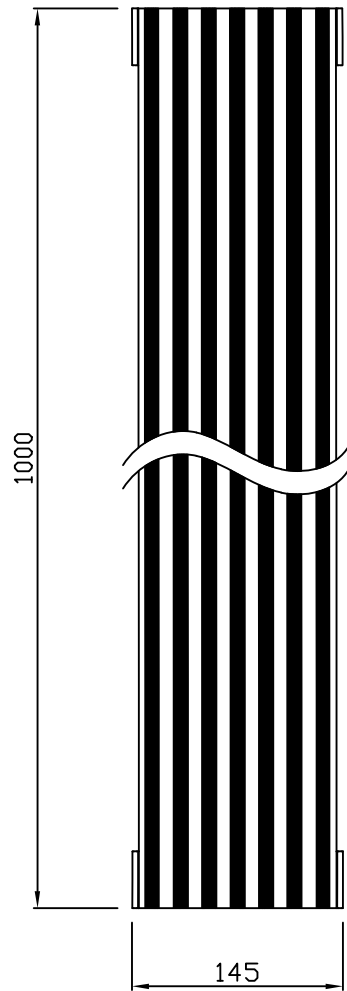

평 면 도  
scale : None

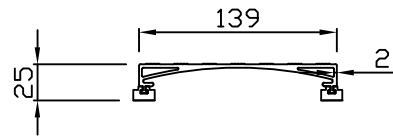

정 면 도  
scale : None

지 지 대

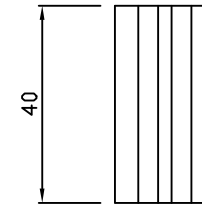

평 면 도  
scale : None

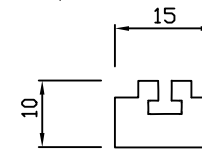

정 면 도  
scale : None

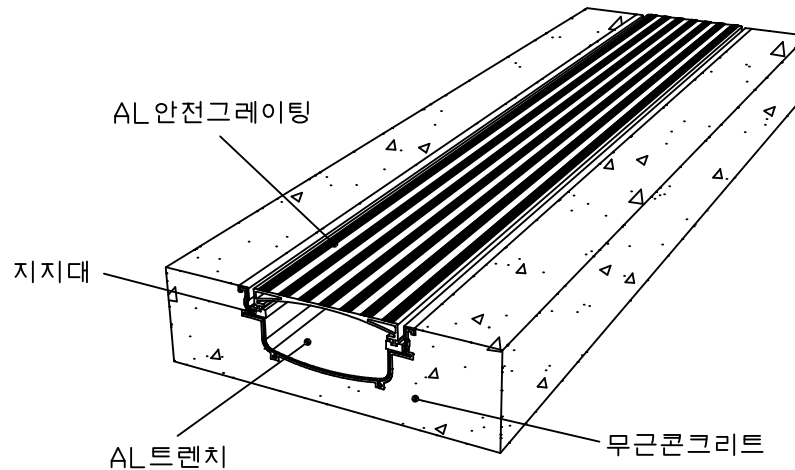

설치예시도  
scale : None

PROJECT TITLE	AL 안전그레이팅	SUBJECT TITLE		DATE	
MATERIAL		WEIGHT		SIZE	145*25*1000

Kg

NOTE.

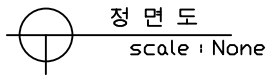
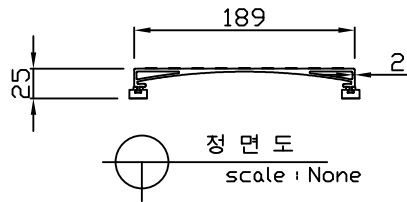
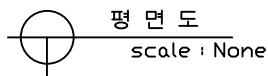
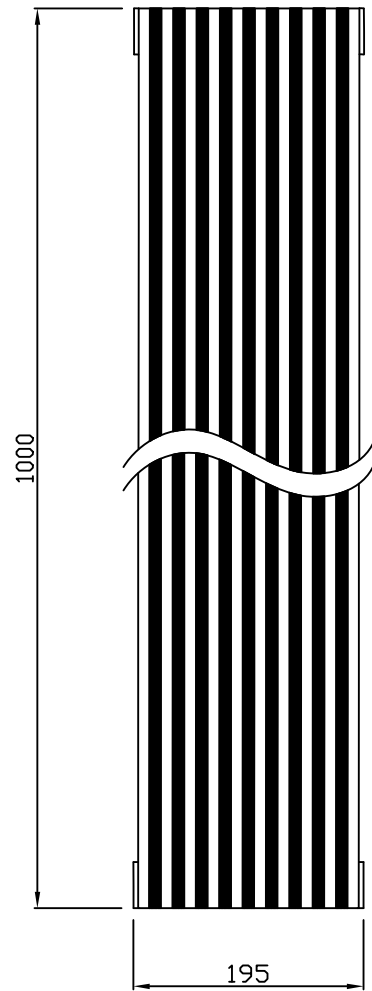

지 지 대

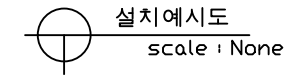
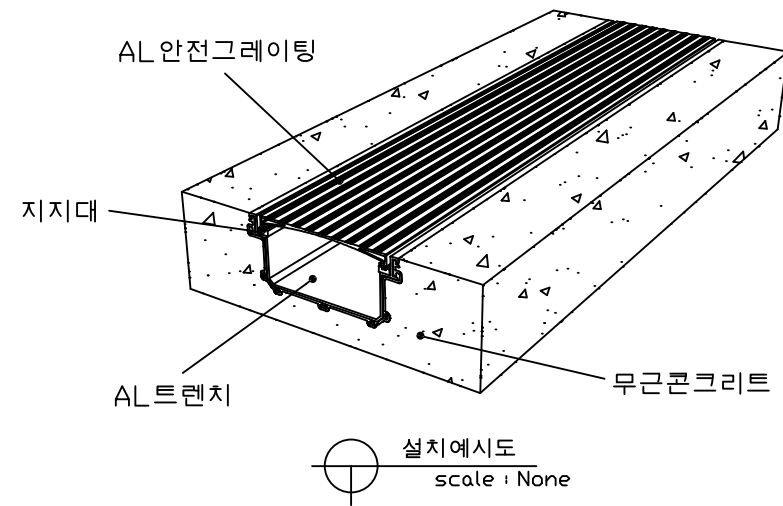
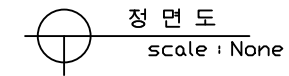
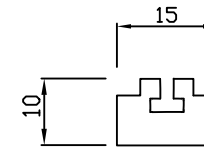
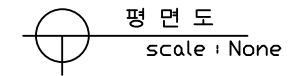
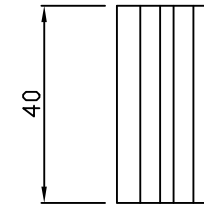

PROJECT TITLE	AL 안전그레이팅	SUBJECT TITLE		DATE	
MATERIAL		WEIGHT		SIZE	195*25*1000
			Kg		

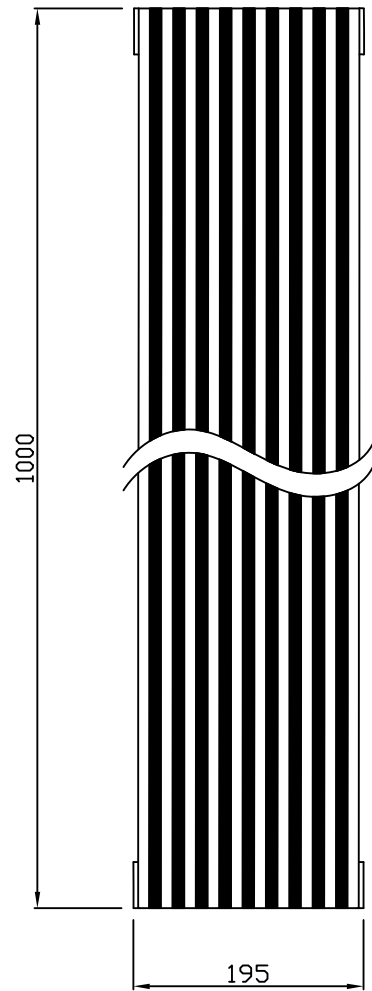

평 면 도  
scale : None

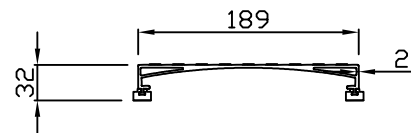

정 면 도  
scale : None

지 지 대

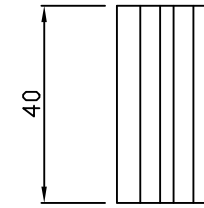

평 면 도  
scale : None

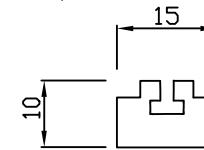

정 면 도  
scale : None

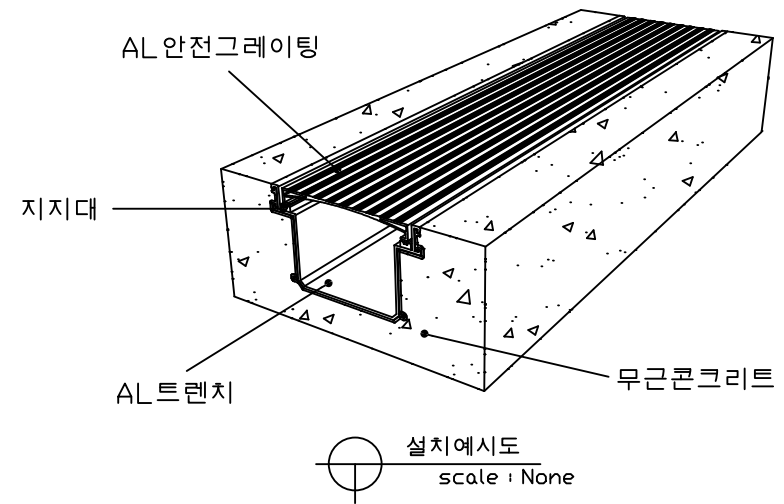

설치예시도  
scale : None

PROJECT TITLE	AL 안전그레이팅	SUBJECT TITLE		DATE	
MATERIAL		WEIGHT	Kg	SIZE	195*32*1000

NOTE.

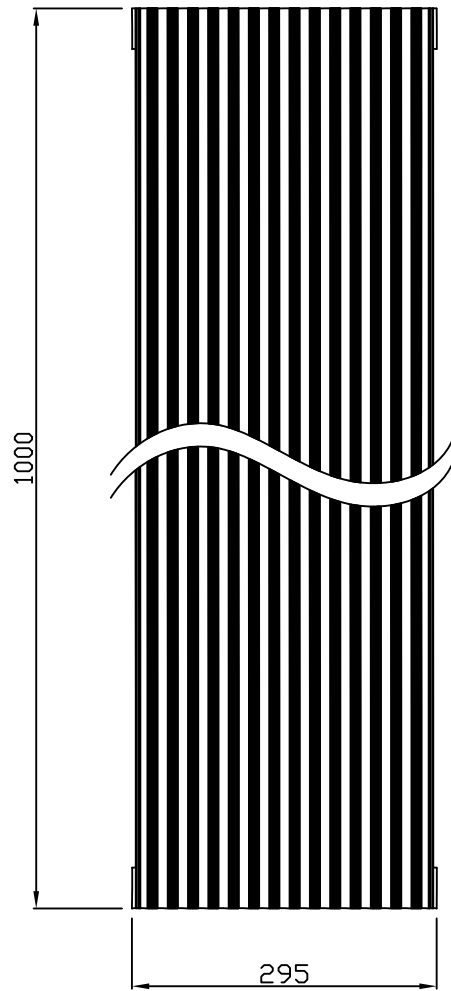

평 면 도  
scale : None

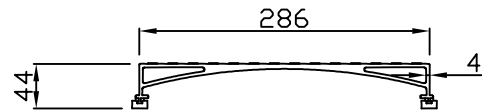

정 면 도  
scale : None

지 지 대

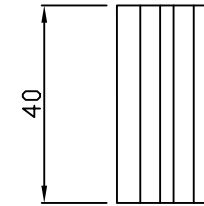

평 면 도  
scale : None

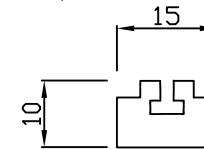

정 면 도  
scale : None

AL 안전그레이팅

지지대

AL 트렌치

무근콘크리트

설치예시도  
scale : None

PROJECT TITLE	AL 안전그레이팅	SUBJECT TITLE		DATE	
MATERIAL		WEIGHT	Kg	SIZE	295*44*1000

NOTE.