

평면도  
scale : None

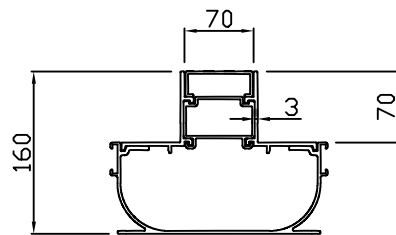

정면도  
scale : None

타공커버

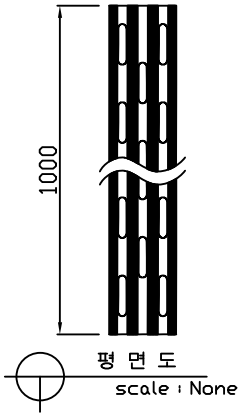

평면도  
scale : None

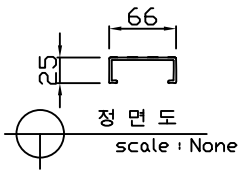

정면도  
scale : None

연결소켓

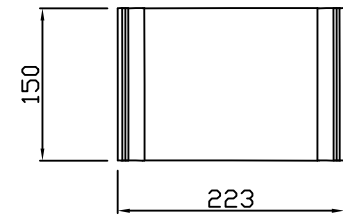

평면도  
scale : None



정면도  
scale : None

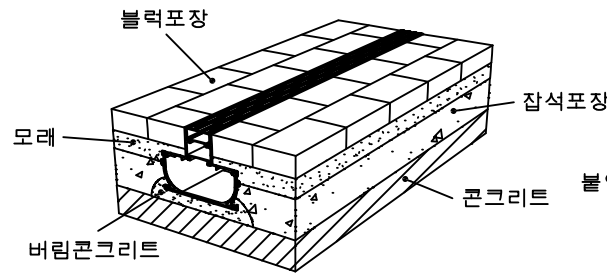

설치예시도 1  
scale : None

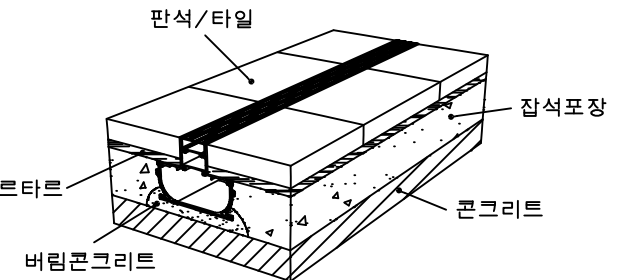

설치예시도 2  
scale : None

PROJECT TITLE	AL수로관	SUBJECT TITLE	DATE
MATERIAL		WEIGHT	SIZE
		Kg	214*160*3000

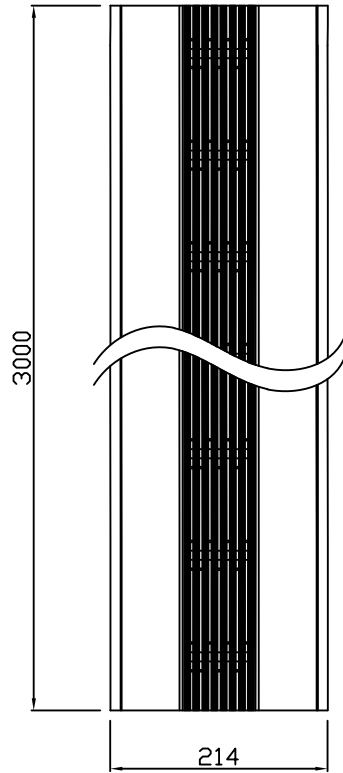

평면도  
scale : None

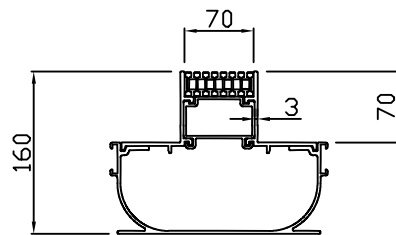

정면도  
scale : None

데크그레이팅

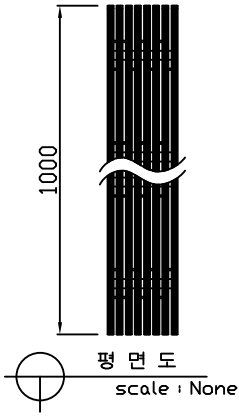

평면도  
scale : None

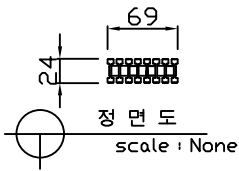

정면도  
scale : None

연결소켓

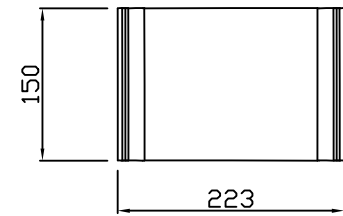

평면도  
scale : None



정면도  
scale : None

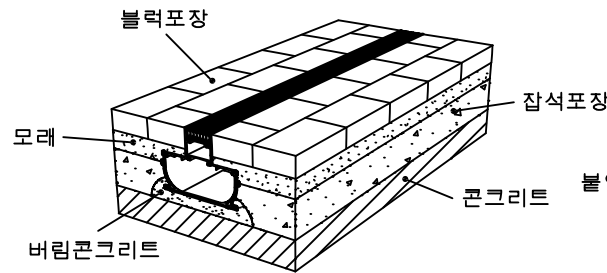

설치예시도 1  
scale : None

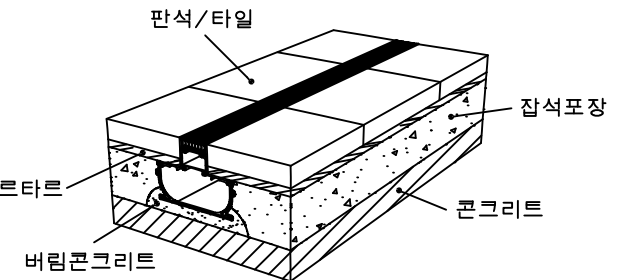

설치예시도 2  
scale : None

PROJECT TITLE	AL수로관	SUBJECT TITLE	DATE
MATERIAL	WEIGHT	SIZE	214*160*3000
	Kg		

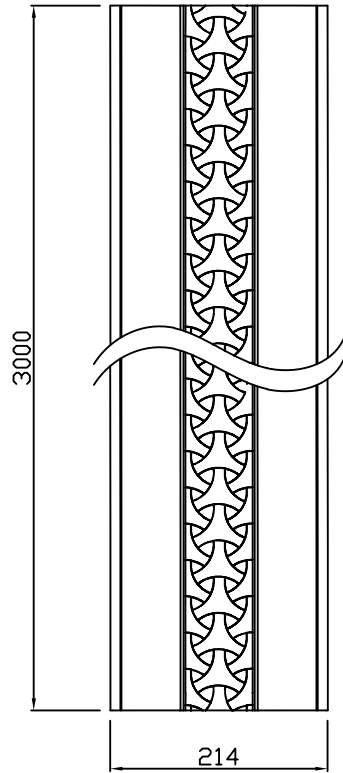

평면도  
scale : None

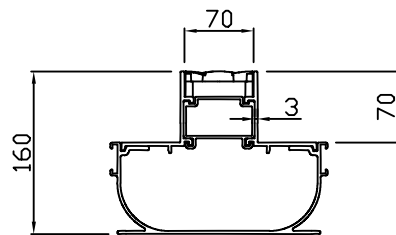

정면도  
scale : None

주철디자인커버

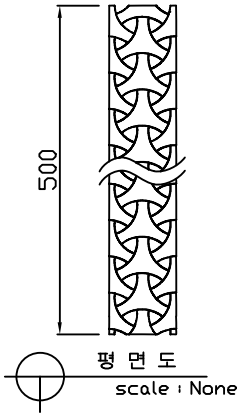

평면도  
scale : None

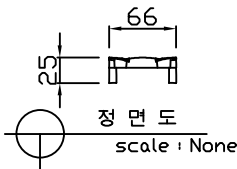

정면도  
scale : None

연결소켓

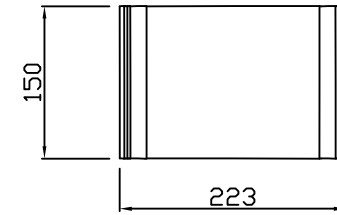

평면도  
scale : None

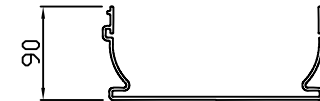

정면도  
scale : None

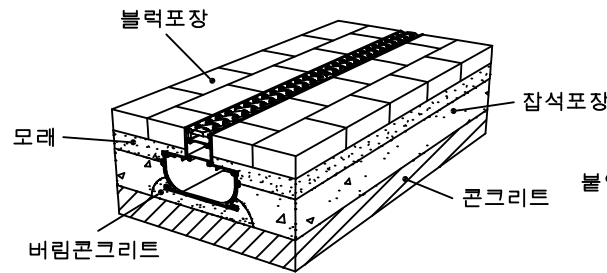

설치예시도 1  
scale : None

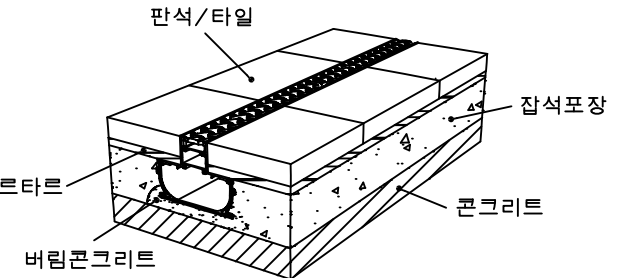

설치예시도 2  
scale : None

PROJECT TITLE	AL수로관	SUBJECT TITLE		DATE	
MATERIAL		WEIGHT	Kg	SIZE	214*160*3000